

B 180 2011 MODEL

UNIT 1

ILLUSTRATED PARTS BREAKDOWN

From Serial Number: 30803707

Edizione 2011
Rev. A

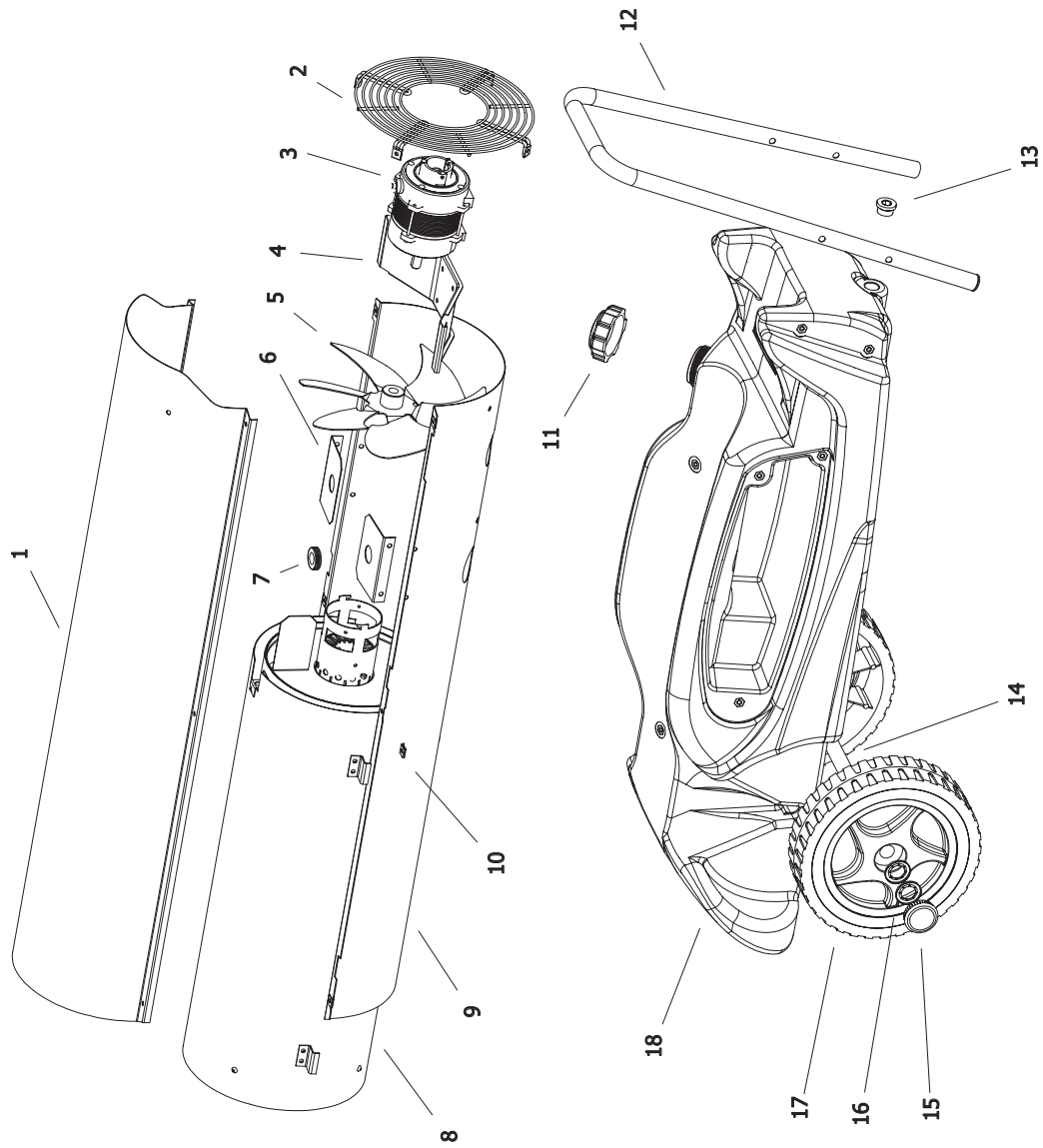

B 180 2011 MODEL

UNIT 2

ILLUSTRATED PARTS BREAKDOWN

From Serial Number: 30803707

Edizione 2011
Rev. A

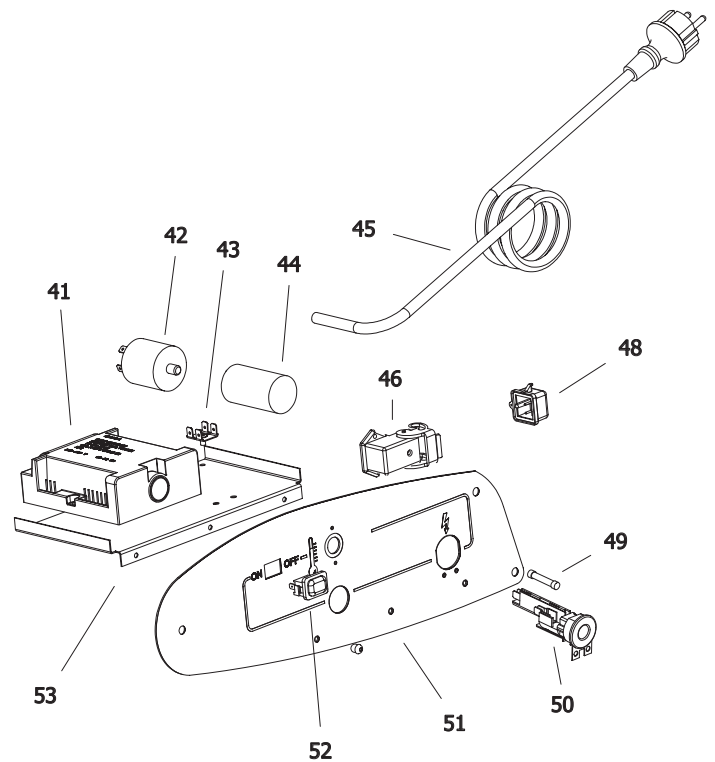
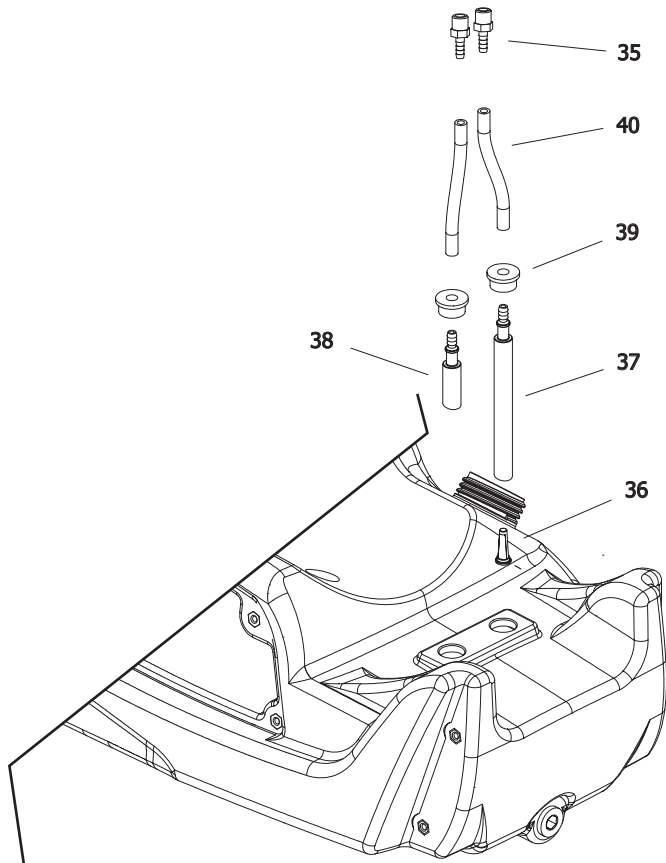
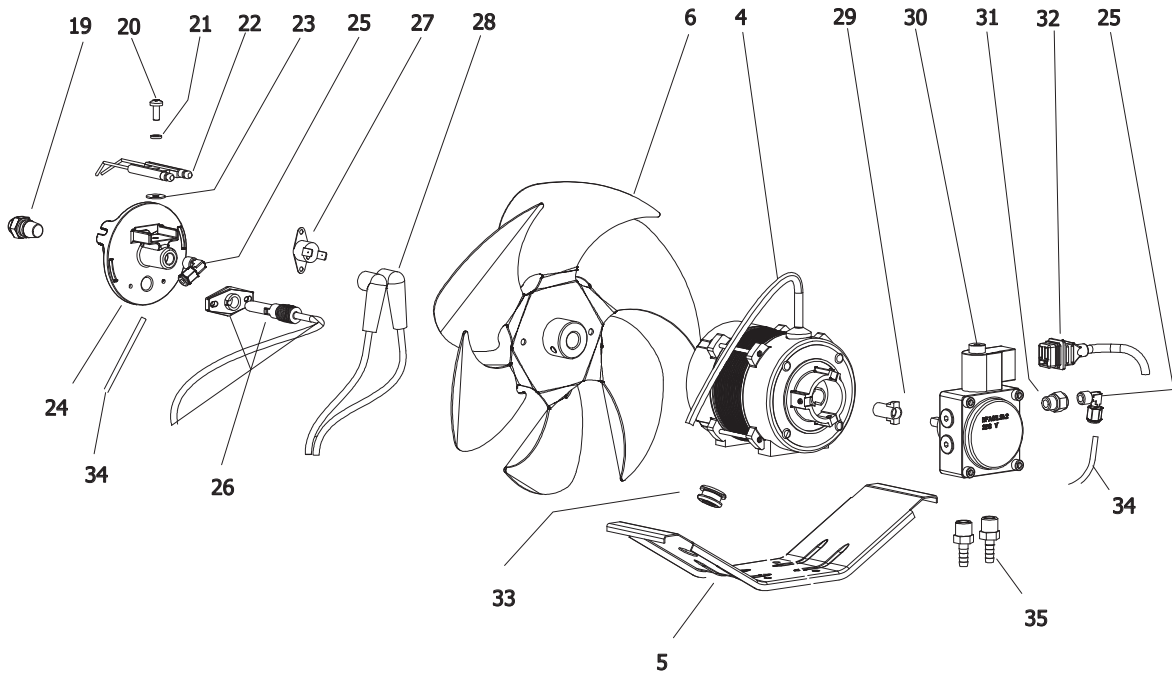

Pos.	Code NR	Description
1	4033.016	UPPER SHELL
2	4032.836	GRID
3	4032.815	MOTOR
4	4032.835	MOTOR BRACKET
5	4032.814	FAN
6	4033.028	AIR FLAP
7	4160.646	CABLE PROTECTION
8	4033.132	COMBUSTION CHAMBER
9	4033.015	LOWER SHELL
10	4104.170	CLIP NUT
11	4032.846	FUEL TANK CAP
12	4032.811	HANDLES
13	4032.813	DRAIN PLUG
14	4032.809	AXLE
15	4111.480	WHEEL PLUG
16	4111.072	WHEEL HOLDER
17	4032.094	WHEEL
18	4033.037	TANK
19	4031.163	NOZZLE
20	4160.601	SCREW
21	4110.393	WASHER
22	4032.396	BIFILAR ELECTRODE
23	4110.394	WASHER
24	4033.042	BURNER FLANGE
25	4161.140	ELBOW
26	4033.022	PHOTOCELL
27	4032.883	LIMIT THERMOSTAT
28	4032.885	HT CABLE
29	4111.081	COUPLING
30	4032.789	PUMP
31	4161.501	NIPPLES
32	4032.905	POWER CORD SOLENOID SPOOL
33	4032.947	CABLE PROTECTION

Pos.	Code NR	Description
34	4032.854	OIL SUPPLY PIPE
35	4032.906	FITTING 1/4"
36	4110.356	FUEL FILTER
37	4110.355	FUEL LINE TANK-PUMP
38	4033.038	FUEL PIPE PUMP-TANK
39	4100.541	RUBBER BUSHING
40	4110.032	FUEL LINE
41	4033.017	IGNITION CONTROL ASSEMBLY
42	4032.771	POWER LINE RFI FILTER
43	4160.639	POP RIVET WITH TERMIN. 4 WAY
44	4032.816	CAPACITOR 6,3 μ f
45	4111.153	POWER CORD
46	4111.119	THERMOSTAT SOCKET
48	4162.467	CAP FOR THERMOSTAT SOCKET
49	4032.850	FUSE (6,3X32) 15A
50	4111.038	STRAIN RELIEF
51	4032.823	ELECTR. COMPONENTS PANEL
52	4100.667	ON/OFF SWITCH
53	4032.897	ELECTR. COMPONENTS BASE